



P - Instruções de montagem		F - Instructions de montage		E - Instrucciones de montaje	
GB - Installation instructions		D - Montageanweisungen			
	C	L	A		
0501	404	96	252	330 x 75	



E



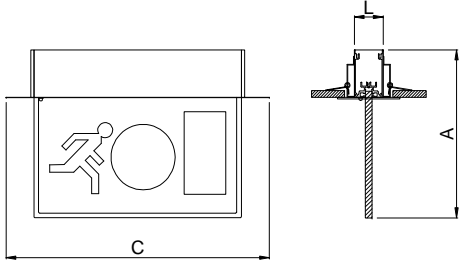
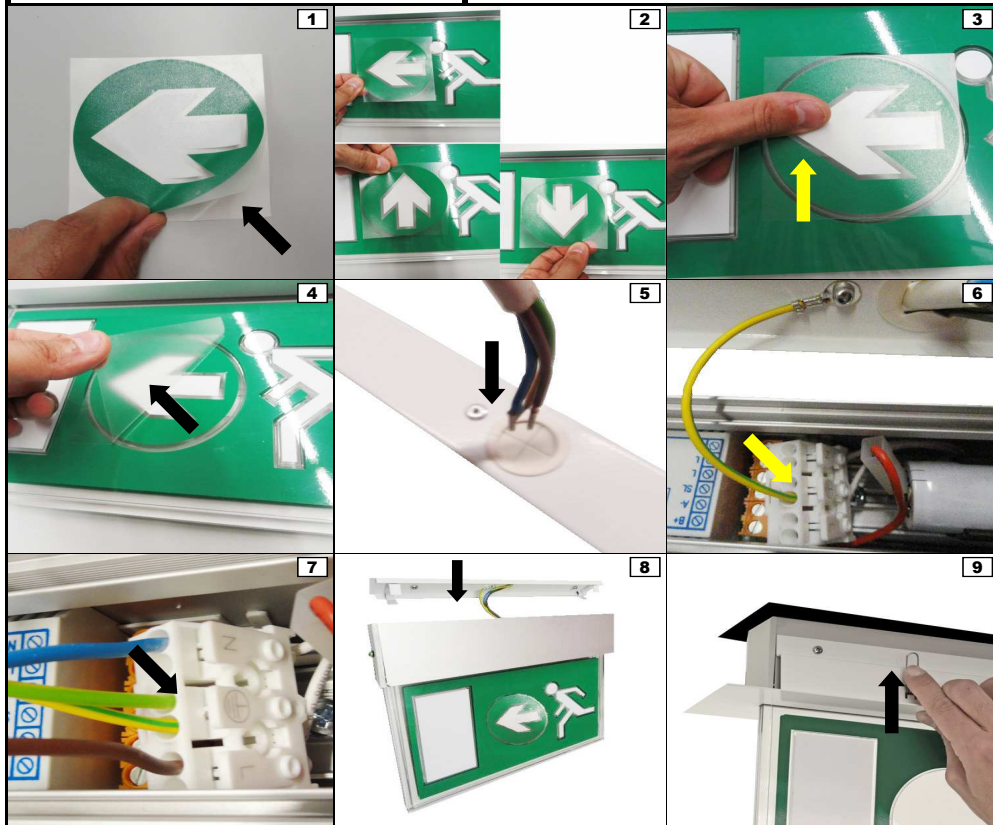

P - Instruções de montagem		F - Instructions de montage		E - Instrucciones de montaje	
GB - Installation instructions		D - Montageanweisungen			
				10	



10

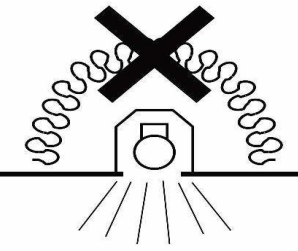

P - Esta luminária não deve, em circunstância alguma, ser coberta por material isolante térmico ou semelhante.

GB - This luminaire shall, under no circumstances, be covered with thermal insulating matting, or similar material.

F - Cette luminaire, en toutes circonstances, ne doit pas être recouvert avec un matériau isolant thermique, ou similaire.

E - Esta luminaria no deve, en ninguna circunstancia, ser cubierta por material aislante térmico, o similar.

D - Diese Leuchte soll, unter keinen Umständen, mit thermische isolierende Material oder ähnliches Material bedeckt werden.

	C	L	A	
0501	404	96	252	330 x 75

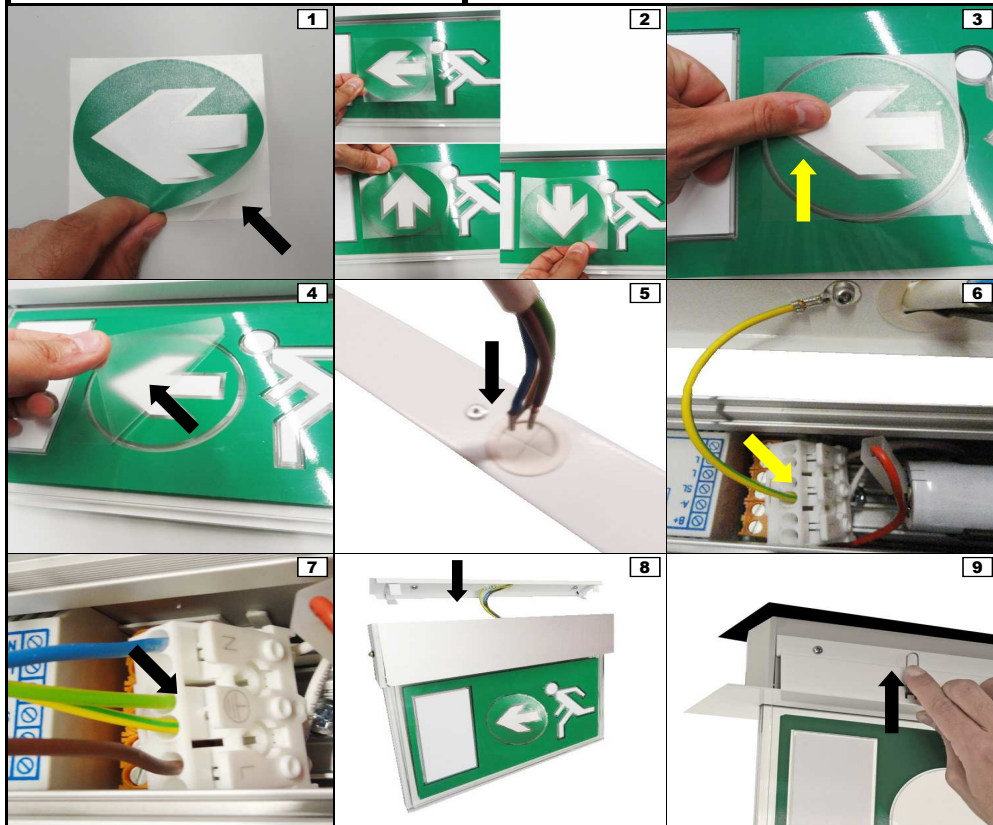
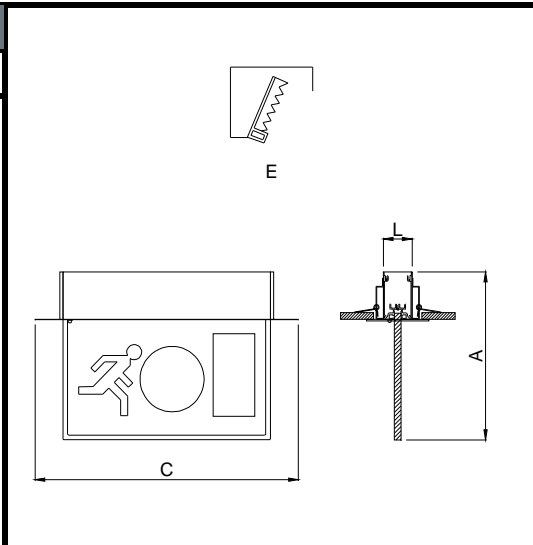

10

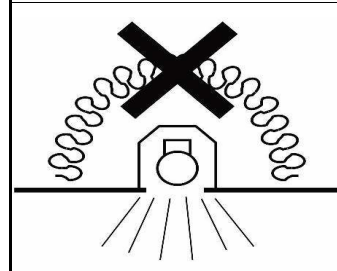

P - Esta luminária não deve, em circunstância alguma, ser coberta por material isolante térmico ou semelhante.  
 GB - This luminaire shall, under no circumstances, be covered with thermal insulating matting, or similar material.  
 F - Cette luminaire, en toutes circonstances, ne doit pas être recouvert avec un matériau isolant thermique, ou similaire.  
 E - Esta luminaria no deve, en ninguna circunstancia, ser cubierta por material aislante térmico, o similar.  
 D - Diese Leuchte soll, unter keinen Umständen, mit thermische isolierende Material oder ähnliches Material bedeckt werden.

