





P - Instruções de montagem		F - Instructions de montage		E - Instrucciones de montaje	
GB - Installation instructions		D - Montageanweisungen			
Watt	C	L	A		
2 x 					
14/24	595	295	104	581 x 275	
21/39	895	295	104	881 x 275	
36/28/54	1195	295	104	1181 x 275	
58/35/49/80	1495	295	104	1481 x 275	
4x18/14/24	595	595	104	581 x 581	
A → BE/BRF B → BFM					



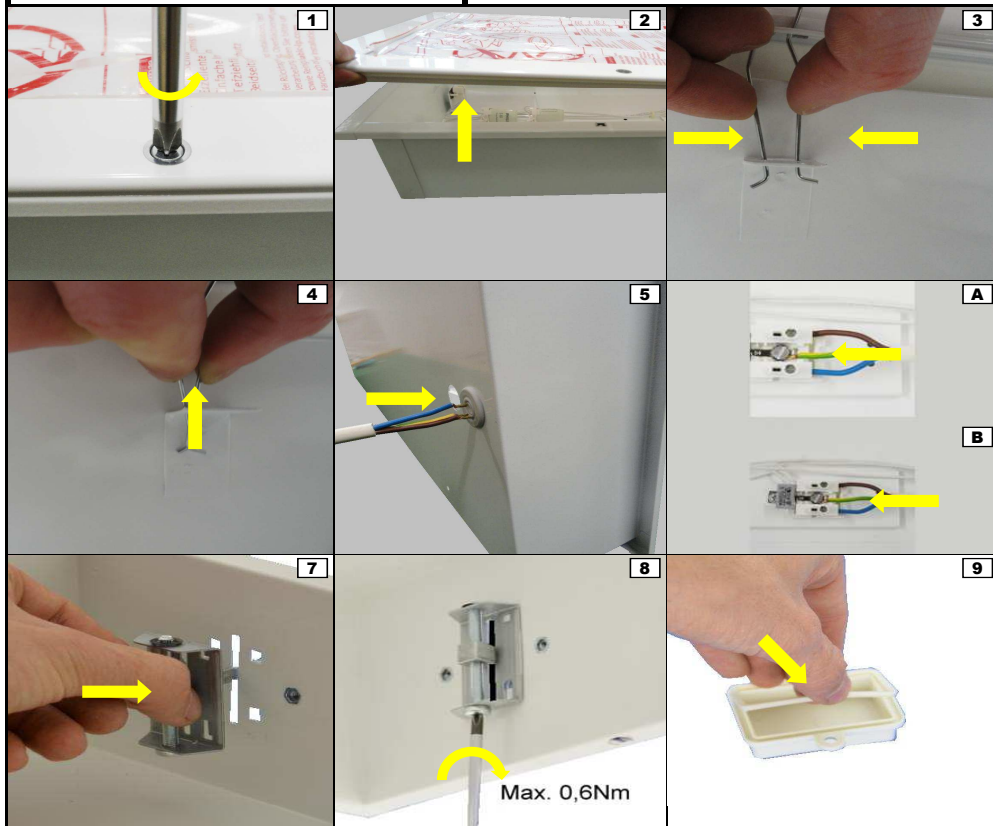
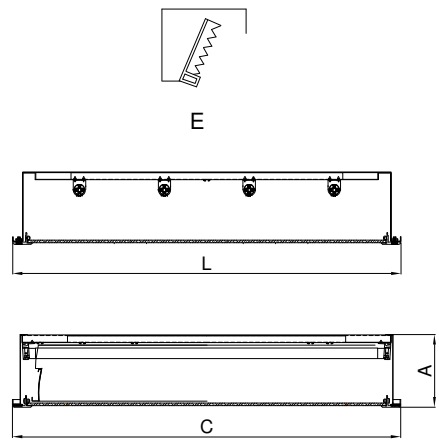
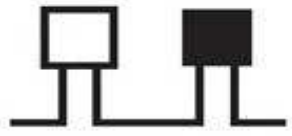

P - Instruções de montagem		F - Instructions de montage		E - Instrucciones de montaje	
GB - Installation instructions		D - Montageanweisungen			









P - Esta luminária é adequada para repicagem. A corrente máxima total admissível é de 10A.
GB - This luminaire is suitable for looping-in connection. The maximum total current in circuit is 10A.
F - Ce luminaire est préparé pour repiquage. La courant total maximal au circuit est 10A.
E - Esta luminaria es adecuada para interconexión. La corriente máxima total del circuito es 10A.
D - Diese Beleuchtung ist für Loop-in Verbindung verwendbar. Der maximale zulässige totalstrom ist 10A.

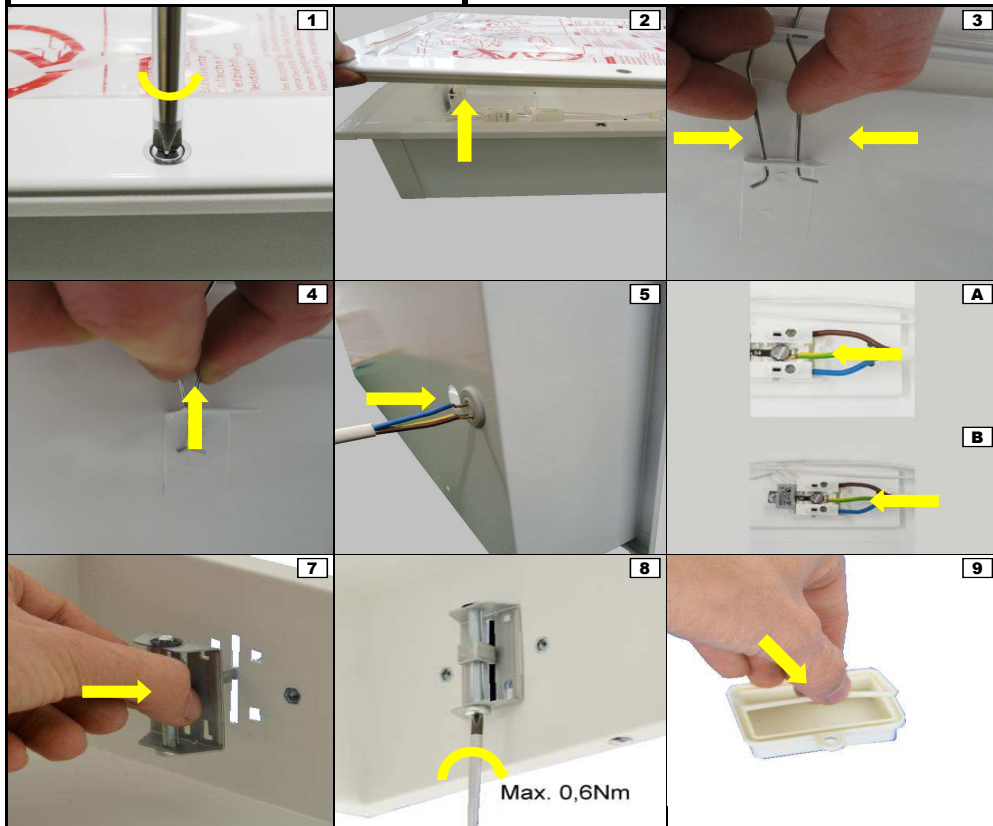
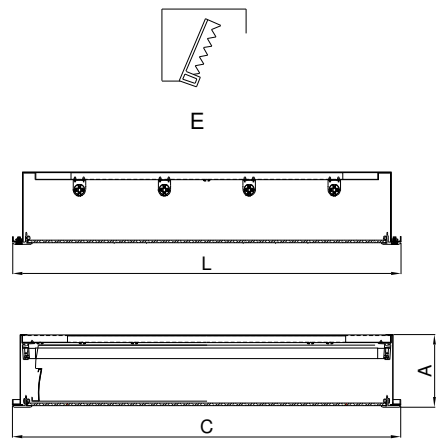

P - Esta luminária não deve, em circunstância alguma, ser coberta por material isolante térmico ou semelhante.
GB - This luminaire shall, under no circumstances, be covered with thermal insulating matting, or similar material.
F - Cette luminaire, en toutes circonstances, ne doit pas être recouvert avec un matériau isolant thermique, ou similaire.
E - Esta luminaria no deve, en ninguna circunstancia, ser cubierta por material aislante térmico, o similar.
D - Diese Leuchte soll, unter keinen Umständen, mit thermische isolierende Material oder ähnliches Material bedeckt werden.

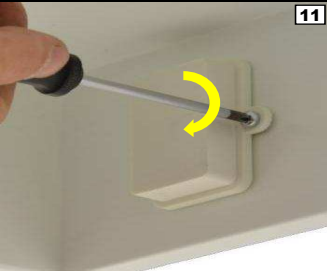
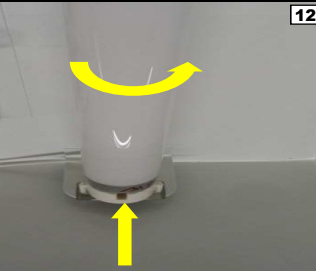
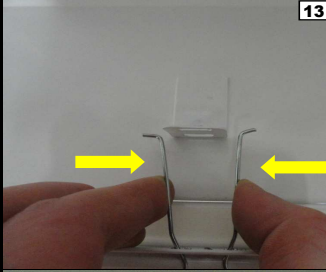
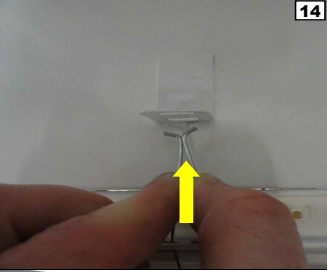
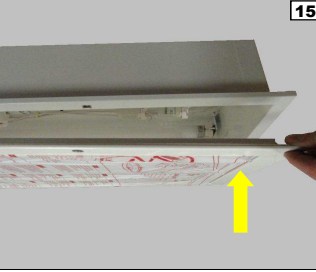
P - Instruções de montagem	F - Instructions de montage	E - Instrucciones de montaje		
GB - Installation instructions	D - Montageanweisungen			
Watt	C	L	A	
2 x 				
14/24	595	295	104	581 x 275
21/39	895	295	104	881 x 275
36/28/54	1195	295	104	1181 x 275
58/35/49/80	1495	295	104	1481 x 275
4x18/14/24	595	595	104	581 x 581
A → BE/BRF				
B → BFM				

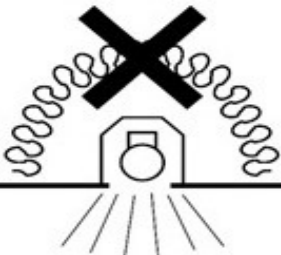

P - Instruções de montagem	F - Instructions de montage	E - Instrucciones de montaje	
GB - Installation instructions	D - Montageanweisungen		
			
			
			
	<p>P - Esta luminária é adequada para repicagem. A corrente máxima total admissível é de 10A. GB - This luminaire is suitable for looping-in connection. The maximum total current in circuit is 10A. F - Ce luminaire est préparé pour repiquage. La courant total maximal au circuit est 10A. E - Esta luminaria es adecuada para interconexión. La corriente máxima total del circuito es 10A. D - Diese Beleuchtung ist für Loop-in Verbindung verwendbar. Der maximale zulässige totalstrom ist 10A.</p>		
	<p>P - Esta luminária não deve, em circunstância alguma, ser coberta por material isolante térmico ou semelhante. GB - This luminaire shall, under no circumstances, be covered with thermal insulating matting, or similar material. F - Cette luminaire, en toutes circonstances, ne doit pas être recouvert avec un matériau isolant thermique, ou similaire. E - Esta luminaria no deve, en ninguna circunstancia, ser cubierta por material aislante térmico, o similar. D - Diese Leuchte soll, unter keinen Umständen, mit thermische isolierende Material oder ähnliches Material bedeckt werden.</p>		